

ROHS G137

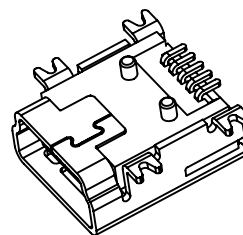
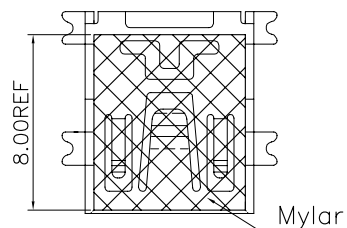
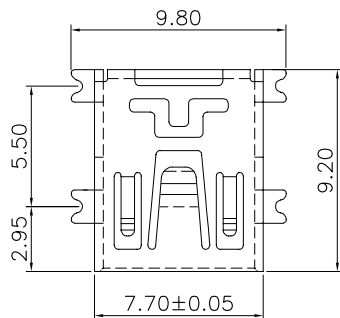

3D VIEW

Note:

1. Material:
 - 1.1 Housing: LCP Plastic(UL94V-0);
 - 1.2 Contact Material:Phosphor Bronze C5191
 - 1.3 Shell Material:Copper alloy C2680
2. Electrical specifications
 - 2.1 Rated current and voltage
1.0A 30V AC/DC
 - 2.2 Dielectric Withstanding Voltage
100V AC for one minute Between adjacent terminal,No Breakdown
 - 2.3 Contact Resistance
50mΩ Max
 - 2.4 Insulation Resistance
100MΩ Min 100V DC For 1 Minute Between adjacent Terminal
 - 2.5 Operation Temperature
-25°C ~ +80°C

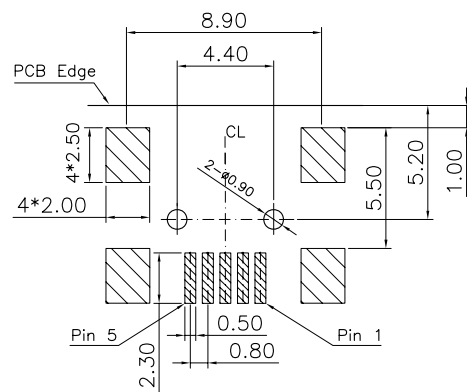
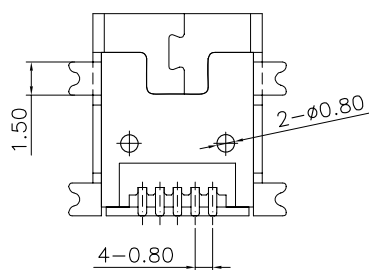
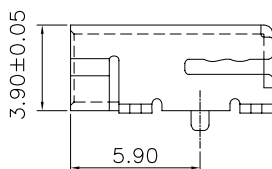
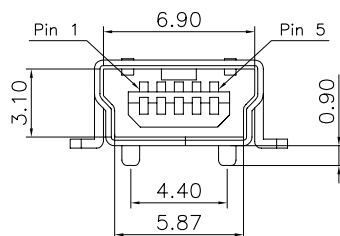

RECOMMENDED PCB LAYOUT

PART NO. LEGEND:

U4F05U-C1N1-X

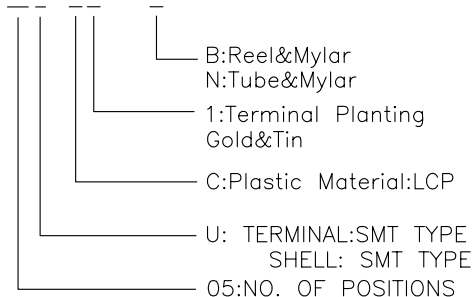

E				DRAWING:	GENERAL TOLERANCE .X:=±0.30 .X':=±2° .XX:=±0.20 .XX':=±1° .XXX:=±0.10 .XXX':=±0.5°
D			Hu yatao		
C			CHECKED: Tony		
B			APPROVAL:	UNIT: MM	PROJECTION:
A			Yang jie	SCALE: N/A	
NO.	DATE	DESCRIPTION	APPROVAL	SHEET: 1/1	



CHIN-BAN
electronics (H.K.) co., ltd

DESCRIPTION:	
Mini USB 5P Female Conn. SMT B-Type	
PART NO:	U4F05U-C1N1-X
REV:	1.0
CUSTOMER NO:	SIZE: A4