

RoHS

NO.	COMPONENTS	MATERIALS	SPECIFICATION:FINISH/COLOR	QTY.
1	HOUSING	LCP, NYLON9T UL94V-0	NATURAL/BLACK	1
2	TERMINAL	BRASS	THE SURFACE: Au(LAST)	N
3	CAP	LCP, NYLON9T UL94V-0	NATURAL/BLACK	1

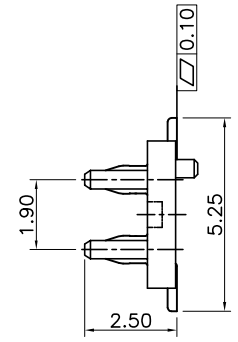
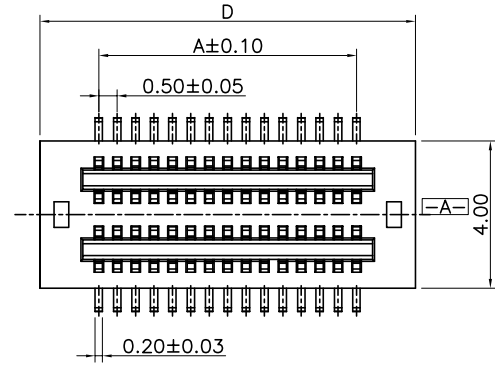
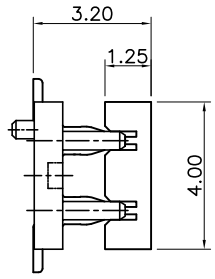

NOTE:

1. ALL MATERIAL MUST BE COMPLY WITH RoHS.
2. PART NO. LEGEND:

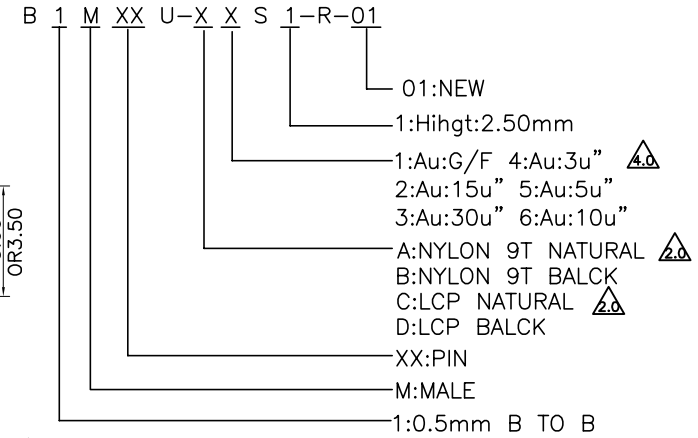

Pin	A	B	C	D
2x5	2.00	2.88	3.90	5.20
2x6	2.50	3.38	4.40	5.70
2x7	3.00	3.88	4.90	6.20
2x8	3.50	4.38	5.40	6.70
2x9	4.00	4.88	5.90	7.20
2x10	4.50	5.38	6.40	7.70
2x11	5.00	5.88	6.90	8.20
2x12	5.50	6.38	7.40	8.70
2x13	6.00	6.88	7.90	9.20
2x14	6.50	7.38	8.40	9.70
2x15	7.00	7.88	8.90	10.20
2x16	7.50	8.38	9.40	10.70
2x17	8.00	8.88	9.90	11.20
2x18	8.50	9.38	10.40	11.70
2x19	9.00	9.88	10.90	12.20
2x20	9.50	10.38	11.40	12.70
2x21	10.00	10.88	11.90	13.20
2x22	10.50	11.38	12.40	13.70
2x23	11.00	11.88	12.90	14.20
2x24	11.50	12.38	13.40	14.70
2x25	12.00	12.88	13.90	15.20
2x26	12.50	13.38	14.40	15.70
2x27	13.00	13.88	14.90	16.20
2x28	13.50	14.38	15.40	16.70
2x29	14.00	14.88	15.90	17.20
2x30	14.50	15.38	16.40	17.70

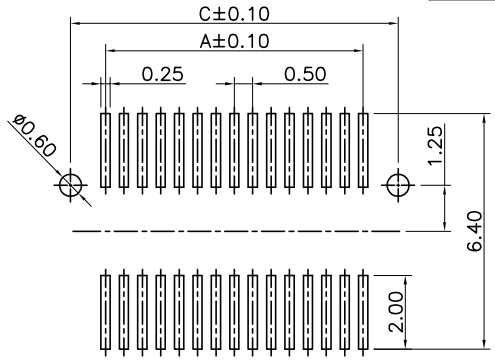
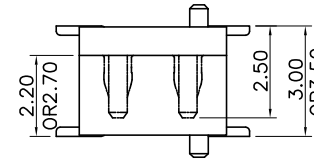
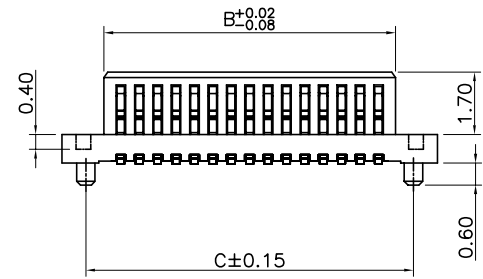

ELECTRICAL PERFORMANCE

1. RATED VOLTAGE(MAX.):50V AC/DC
2. RATED CURRENT(MAX.):0.5A AC/DC
3. CONTACT RESISTANCE:40 MILLIOHM MAX.
4. INSULATION RESISTANCE:100 MEGOHMS MIN. 250V DC FOR 1 MINUTE BETWEEN ADJACENT TERMINAL
5. DIELECTRIC STRENGTH: 250V AC FOR 1 MINUTE BETWEEN ADJACENT TERMINAL NO BREAKDOWN
6. OPERATING TEMPERATURE: -25° to +85°

5.0					
4.0	2016.6.3	追加电镀规格	Tian hai	DRAWING: Henry	GENERAL TOLERANCE .X:±0.30 .X':=±2" .XX:±0.20 .XX':=±1" .XXX:±0.10 .XXX':=±0.5"
3.0	2014.12.17	修订定位柱尺寸公差	XiaoYong	CHECKED: Tian Hai	
2.0	2014.9.19	ADDITIONAL NATURAL COLOR	XiaoYong	APPROVAL: Tian Hai	UNIT: MM PROJECTION: SCALE: 1/1
1.0	2014.9.12	NEW	XiaoYong		SHEET: 1/1
NO.	DATE	DESCRIPTION	APPROVAL	Tian Hai	

5.0					
4.0	2016.6.3	追加电镀规格	Tian hai	DRAWING: Henry	GENERAL TOLERANCE .X:±0.30 .X':=±2" .XX:±0.20 .XX':=±1" .XXX:±0.10 .XXX':=±0.5"
3.0	2014.12.17	修订定位柱尺寸公差	XiaoYong	CHECKED: Tian Hai	
2.0	2014.9.19	ADDITIONAL NATURAL COLOR	XiaoYong	APPROVAL: Tian Hai	UNIT: MM PROJECTION: SCALE: 1/1
1.0	2014.9.12	NEW	XiaoYong		SHEET: 1/1
NO.	DATE	DESCRIPTION	APPROVAL	Tian Hai	



CHIN-BAN
electronics (H.K) co., ltd

DESCRIPTION: 0.5mm Board to Board Male 2.50mm Height(New)	
PART NO: B1MXXU-XXS1-R-01	REV: 4.0
DRAWING NO: UK0150	SIZE: A4