

ORDERING INFORMATION

U 1 F 04 H - X X N - XX
 (1)(2)(3) (4) (5) (6)(7)(8) (9)

- SERIES NO.
U: USB CONNECTOR SERIES
- USB TYPE
1: USB 4PIN A TYPE
F: FEMALE
- USB MALE & FEMALE TYPE
- NUMBER OF PIN
04: 4 POSITIONS
- TAIL CONSTRUCTION TYPE
H: TERMINAL: DIP TYPE
SHELL: DEEP TYPE
- HOUSING COLOR CODE AND MATERIAL
A: COLOR:WHITE AND MATERIAL:PBT
B: COLOR:WHITE AND MATERIAL:LCP
C: COLOR:BLACK AND MATERIAL:PBT
D: COLOR:BLACK AND MATERIAL:LCP
- CONTACT PLATING
1: GOLD FLASH OVER NICKEL ON CONTACT AREA AND 100u" MIN. TIN PLATING OVER NICKEL ON SOLDER TAILS
2: 15u"GOLD PLATING OVER NICKEL ON CONTACT AREA AND 100u" MIN. TIN PLATING OVER NICKEL ON SOLDER TAILS
3: 30u"GOLD PLATING OVER NICKEL ON CONTACT AREA AND 100u" MIN. TIN PLATING OVER NICKEL ON SOLDER TAILS
4: 3u"GOLD PLATING OVER NICKEL ON CONTACT AREA AND 100u" MIN. TIN PLATING OVER NICKEL ON SOLDER TAILS
- SHELL PLATING
N: NICKEL PLATING
- SHELL MATERIAL
01: PHOSPHOR BRONZE
05: SPCC

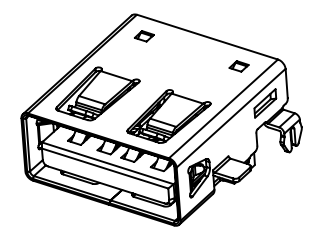
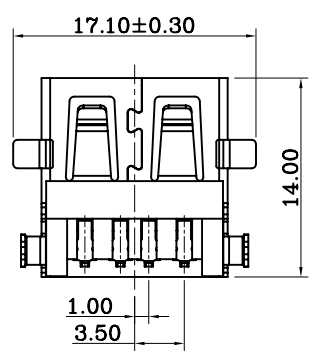
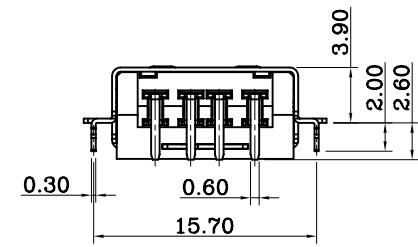
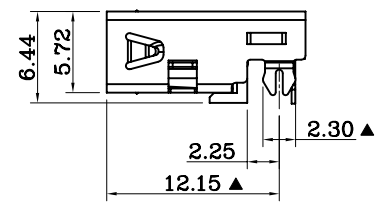
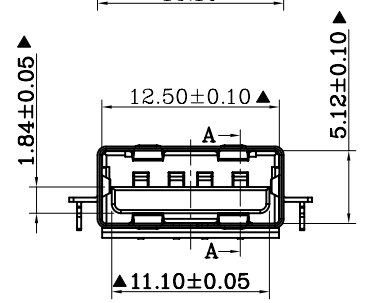

MATERIAL SPECIFICATION:

- HOUSING:PBT/LCP PLASTIC(UL94V-0)
- CONTACT:PHOSPHOR BRONZE
- SHELL:BRASS/SPCC

ELECTRICAL PERFORMANCE

- RATED VOLTAGE(MAX.):30V AC/DC
- RATED CURRENT(MAX.):1.5A AC/DC
- DIELECTRIC STRENGTH:500V AC FOR 1 MINUTE BETWEEN ADJACENT TERMINAL, NO BREAKDOWN
- INSULATION RESISTANCE:1000 MEGOHMS MIN. 500V DC FOR 1 MINUTE BETWEEN ADJACENT TERMINAL
- CONTACT RESISTANCE:30 MILLIOHM MAX.
- OPERATING TEMPERATURE:-55° to +85°

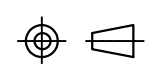
| | | | | | | | |
|-----|------------|-------------|----------|---|---|---|---|
| 5 | | | | DRAWING: | GENERAL TOLERANCE | |  <p>CHIN-BAN electronics (H.K) co., ltd</p> |
| 4 | | | Match | .X:±0.30 .X':±2° .XX:±0.20 .XX':±1° .XXX:±0.10 .XXX':±0.5° | | | |
| 3 | | | CHECKED: | UNIT: MM | PROJECTION: | DESCRIPTION: USB 2.0 A Type Female Deep Type 反向式 | |
| 2 | | | Fahir | SCALE: 1/1 |  | | |
| 1 | 2012.08.31 | 新增铜壳与铁壳选项 | Match | APPROVAL: | SHEET: 1/1 | PART NO: U1F04H-XXN-XX | |
| NO. | DATE | DESCRIPTION | APPROVAL | Toms | | DRAWING NO: P2U1F04H-XXN-XX-01 | SIZE: A4 |